

Data Sheet



Article number: 021816025222

Description: Clamp with bracket and rubber
SPGU 6025. 222/30 SK

Measures

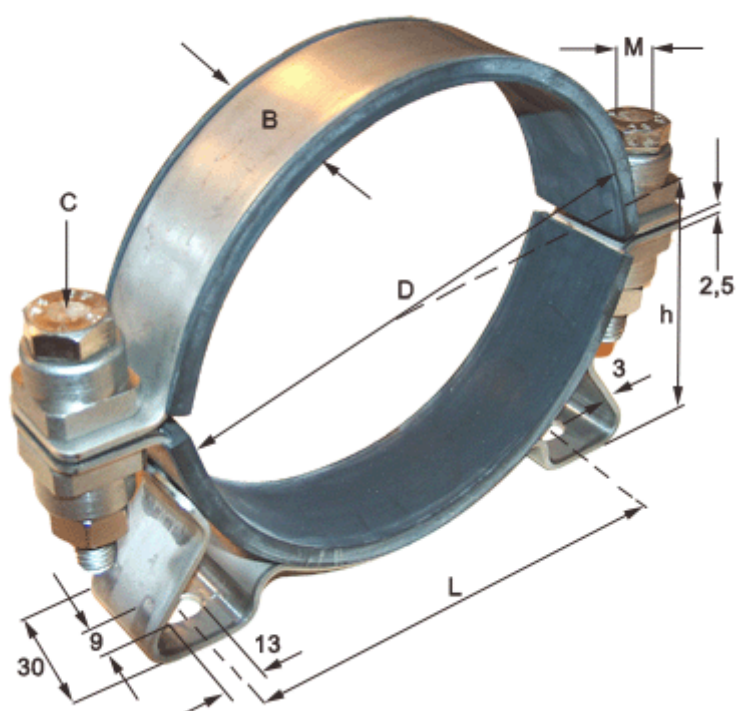

C (screw type) = SK hexagon screw

Diameter D = 222

h = 119

L = 216

Width B = 30